



# LEGIC 4000 series

## General Information

# SM-4x00 EMS Manufacturer Information

CONFIDENTIAL

Classification: Public (Info Level 1)

Document No.: LB-23-101a

Edition: 11.2019



## Table of contents

<b>1</b>	<b>About this document</b> .....	<b>4</b>
	Scope .....	4
	Target users .....	4
	Related documents .....	4
	Terms and abbreviations.....	4
	Document conventions.....	4
	Intended use .....	4
	Change history .....	4
<b>2</b>	<b>Technical data</b> .....	<b>5</b>
	Type designation .....	5
	Ambient conditions .....	5
	Package .....	6
<b>3</b>	<b>Processing</b> .....	<b>7</b>
	PCB plating .....	7
	PCB footprint.....	7
	Solder paste stencil design .....	7
	Soldering conditions .....	7
	Moisture sensitivity .....	8
	ESD protection .....	8
<b>4</b>	<b>Appendix</b> .....	<b>9</b>
	ESD guideline.....	9
	SM-4x00 tray dimensions .....	10
	BT-4000 tape dimensions .....	12
	Color coding of trays for SM-4200(M) .....	14
	Color coding of trays for SM-4500(M) .....	14

# 1 About this document

**Scope** This document provides hardware information of the LEGIC 4000 series reader chips SM-4200 and SM-4500 with hardware versions V1.0, V1.1 and V1.2 and with LEGIC OS-4000 version V4.4.0.0.  
This document includes information relevant for electronics manufacturing services.  
The design of a standard reader and a battery-powered reader with LEGIC 4000 series reader chips SM-4200 and SM-4500 is described in separate application notes.

**Target users** This document is aimed at hardware and software engineers of electronics manufacturing services (EMS).

**Related documents** For further information, refer to the following documents:

Ref	Document Type	Title	Doc. No.
	Declaration on conformity	RoHS Compliance	LZ-01-001
	Statement	Statement on REACH Regulation	LZ-01-006

Table 1: Related documents

**Terms and abbreviations** The following table lists only terms and abbreviations used exclusively in this document:

Term	Description
SM-4x00	Abbreviation for any 4000 series reader chip type (SM-4200, SM-4300 and SM-4500)

Table 2: Terms and abbreviations

## Document conventions



This symbol marks warnings and important passages.

- Remarks (Notes) and examples appear in *italics*
- Hexadecimal figures are represented in the form 0xnm (e.g. 0x23)

**Intended use** The LEGIC 4000 series reader chips may only be used in contactless identification systems (RFID and BLE systems).

Change history	Change	Edition	Doc. No.
	New edition	11.2019	LB-23-101a

Table 3: Change history

## 2 Technical data

### Type designation

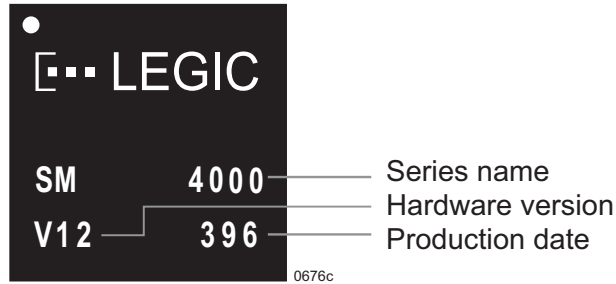

Illustration 1: SM-4x00 type designation

- Notes
- The hardware version can also be read with the `GET_IDB [VERSIONS]` command.
  - The production date is indicated in hexadecimal format.  
 Example: `0x0396` = 918 = year 2009, week 18
  - The firmware version (LEGIC OS-4000) can be read with the `GET_IDB [VERSIONS]` command. Example: `0x01 02 00 00` = V1.2.0.0
  - The reader chips are delivered in trays  
 → see [ ▶ chapter - Appendix ] for details on trays and tray marking
  - To check if a reader chip supports MIFARE transponders (SM-4x00M), use the `GET_IDB [ACTIVATION_BYTE]` command.

### Ambient conditions

Designation	Min.	Typ.	Max.	Conditions
<b>Operation</b>				
Ambient temperature	-25 °C			
Junction temperature			85 °C	
Thermal resistance		7.5 °C/W		junction to case
Power dissipation standard reader		400 mW		RF on, VCC = 5.0 V, I = 120 mA
Power dissipation battery powered reader		200 mW		RF on, VCC = 3.3 V resp. 3.0 V, I = 80 mA
Ambient humidity	5 %rH		95 %rH	without condensation
<b>Storage, transport</b>				
Ambient temperature	-40 °C		105 °C	

Table 4: Ambient conditions

Package	Designation	Value	Conditions
	Type	QFN 56 (MLPQ)	56 pins (+GND plane)
	Grid	0.5 mm	
	Dimensions	8 x 8 x 0.9 mm	→ see dimensional diagram below
	Pin surface plating	Sn	Cu, Sn plated
	Moisture sensitive level (MSL)	3	acc. to JEDEC J-STD-020D, → see "Moisture sensitivity" in chapter 3

Table 5: Package specifications

Dimensional diagram All dimensions in mm.

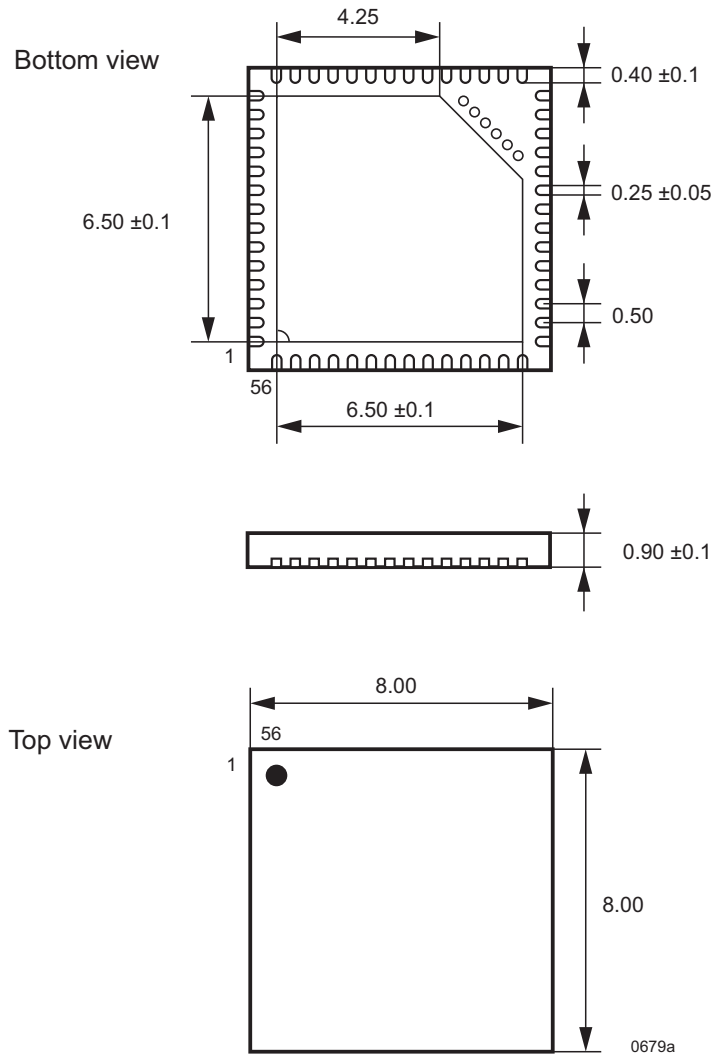

Illustration 2: MLPQ56 package of SM-4x00

### 3 Processing

**PCB plating** It is recommended to use chemical NiAu plating.

**PCB footprint** The following footprint is recommended in the PCB Design → see also the dimensional diagram in [ ▶ chapter 2 - Technical data ]. In order to provide a sufficient heat dissipation, provide vias as indicated. PCB layout files are provided on the LEGIC Extranet.

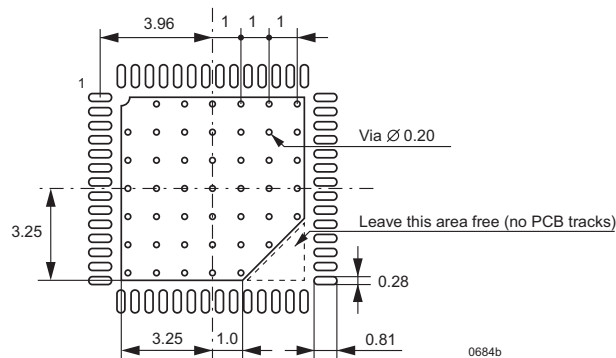

Illustration 3: Footprint of SM-4x00

**Solder Mask clearance** A clearance of 60-75 µm is recommended between the copper land and the solder mask.

**Solder paste stencil design** The following stencil design is recommended for applying the solder paste:

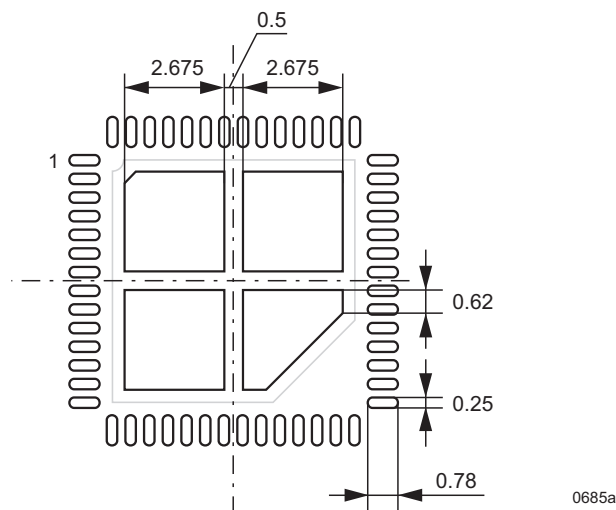

Illustration 4: Solder paste of SM-4x00

Stencil thickness: 120 µm

**Soldering conditions** The following RoHS compliant soldering conditions are recommended:

- Soldering conditions: IPC/JEDEC J-STD-020D
- Solder paste: Lead-free, recommended: ALPHA® OM-338-T
- PCB surface plating: Chem. NiAu
- Soldering profile:

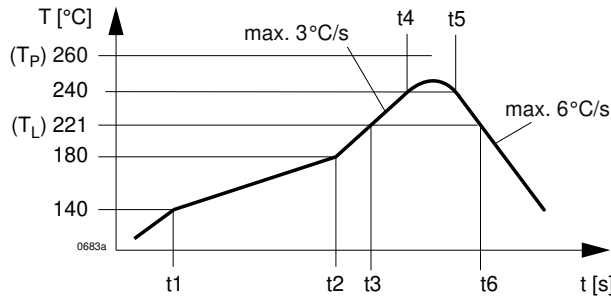

Illustration 5: Soldering profile

	Temperature [°C]	Phase	Time [s]
Preheating	140 ... 180	t1 ... t2	40 ... 60
Heating (liquidus, T <sub>L</sub> )	221	t3 ... t6	60 ... 150
Soldering	240 ... 255	t4 ... t5	16
Max. temperature (T <sub>P</sub> )	260	-	-

Table 6: Soldering profile

**Moisture sensitivity** The reader chip package is sensitive to moisture. Moisture trapped inside the package can expand during the reflow soldering process and thus damage the package (“popcorn” effect).

The reader chip has a moisture sensitive level (MSL) = 3 according to IPC/ JEDEC J-STD-020D.

When removed from the sealed bag, the reader chip must be processed within the time given on the bag label (2 a):



**CAUTION**  
This bag contains **MOISTURE SENSITIVE DEVICES**

LEVEL

3

Level defined by IPC/ JEDEC Standard J-STD-020

1. Shelf life in sealed bag: 12 month at < 40 °C and < 90 % RH
2. After this bag is opened, devices that will be subject to infrared reflow, vapour-phase reflow or equivalent processing must be:
  - a) Mounted within 150 hours at factory conditions of ≤ 30 °C / 60 % RH
  - b) Stored at ≤ 10 % RH
3. Devices require baking, before mounting, if:
  - a) Humidity Indicator Card is >10 % RH when read at 23 ±5 °C
  - b) Conditions 2a or 2b are not met
4. If baking is required, refer to IPC/JEDEC J-STD-033 for bake procedure

Bag Seal Date

12.10.2010

Illustration 6: MSL label

**ESD protection**



**NOTICE**

**Danger to electronical components caused by electrostatic discharge**  
Observe the ESD guideline in --- FEHLENDER LINK ---.



## 4 Appendix

### ESD guideline



---

Please observe the following ESD protection regulations (ESD = Electro- Static Discharge) when handling the microchips:

---

**Handling components** The reader chip has to be kept in the closed original ESD protective packaging at all times when in storage and during transportation. Components may only be removed from the ESD protective packaging in workplaces which are designed for such activities and which are ESD secure. Do not remove the components until you are at the exact location where they will be processed. Components may only be removed from the ESD protective packaging by persons familiar with and observing both the general and the ESD regulations described here.

**Ambient conditions** To avoid static electricity discharge (ESD) while working, comply with the following regulations:

#### General:

- Designate ESD secure zones
- Post the ESD regulations
- Check the ESD protective regulations periodically (electrical conductivity)
- Designate grounded discharge surfaces at the entrance of ESD zones for people who enter
- Ensure sufficient relative humidity (min. 45 %)
- Use only anti-static clear plastic binders (for work papers)
- Instruct participating employees
- Inform non-participating employees
- Ensure that all employees and visitors comply with the regulations

#### Workplace:

- Electrically-conductive work substrate grounded
- Electrically-conductive wristband grounded
- Electrically-conductive work chair
- Electrically-conductive flooring grounded
- Grounded machines and furniture
- Connect all work equipment mentioned above to the same ground potential

#### Employees:

- Always wear (contact with skin) and ground wristband when working
- Wear electrically-conductive work coat
- Wear electrically-conductive shoes or discharging contact strips
- Work with ESD components in ESD secure workplaces only

SM-4x00 tray dimensions

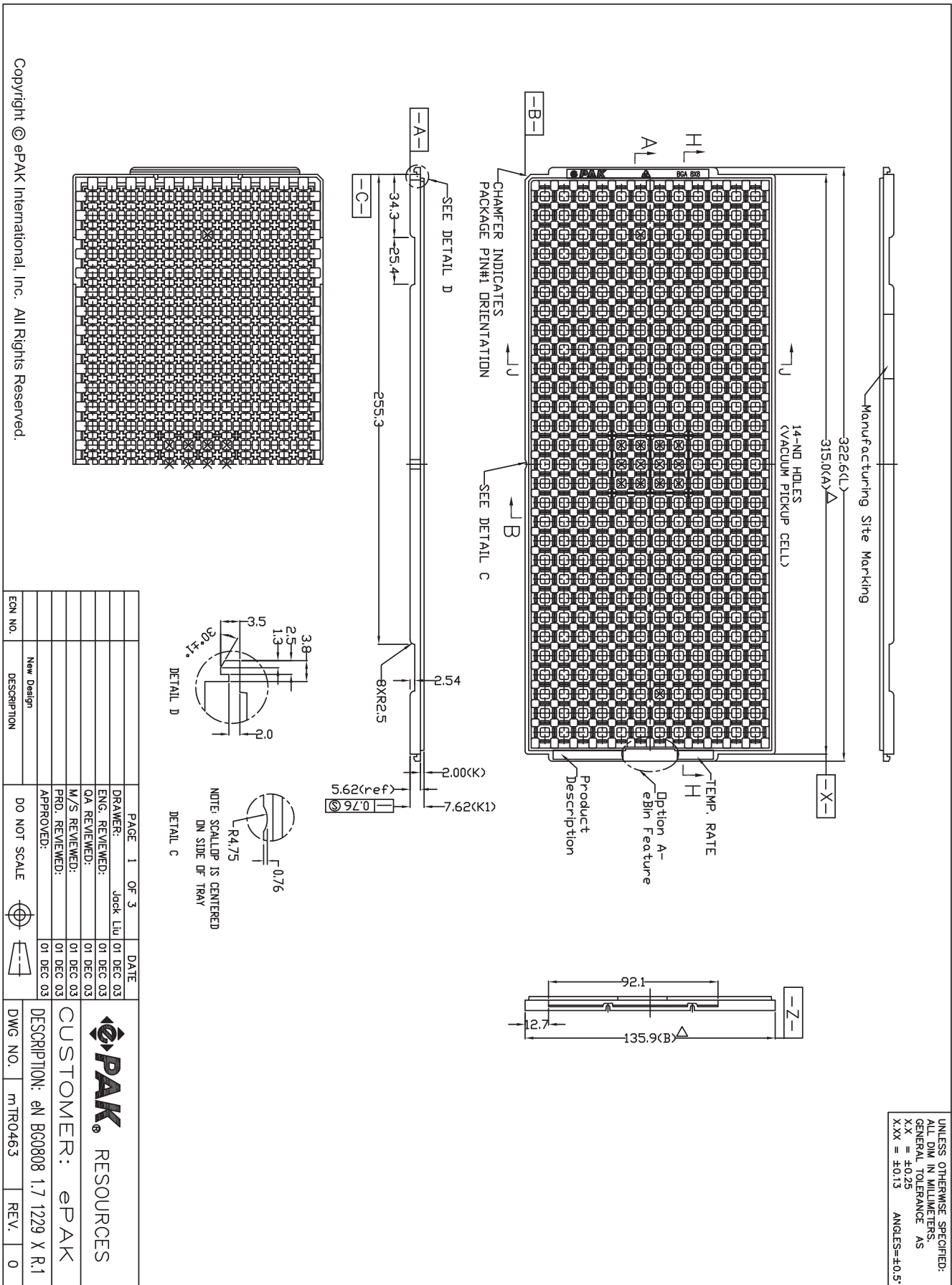

Copyright © ePAK International, Inc. All Rights Reserved.

ECN NO.	DESCRIPTION	DO NOT SCALE	DATE	DESCRIPTION
			PAGE 1 OF 3	
			DRAWER: Jack Liu	01 DEC 03
			ENG. REVIEWED:	01 DEC 03
			QA REVIEWED:	01 DEC 03
			M/S REVIEWED:	01 DEC 03
			PRD. REVIEWED:	01 DEC 03
			APPROVED:	01 DEC 03
			<b>ePAK</b> RESOURCES	
			CUSTOMER: ePAK	
			DESCRIPTION: eN B00808 1.7 1229 X R.1	
			DWG NO.	REV.
			mTRO463	0

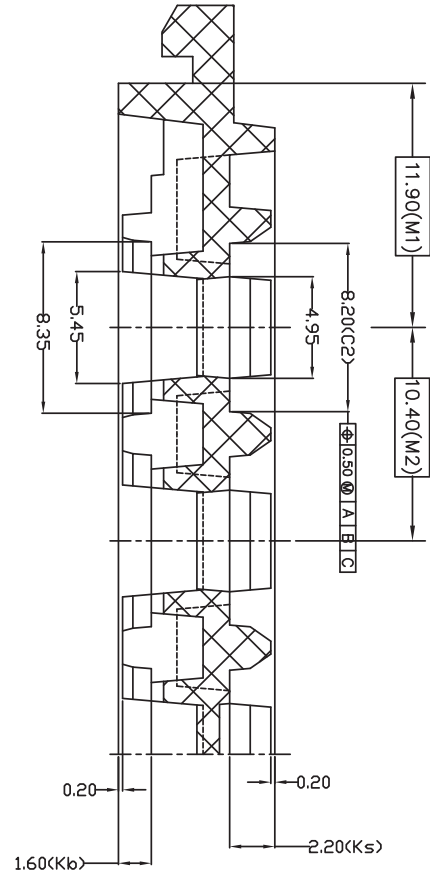

SECTION A-A

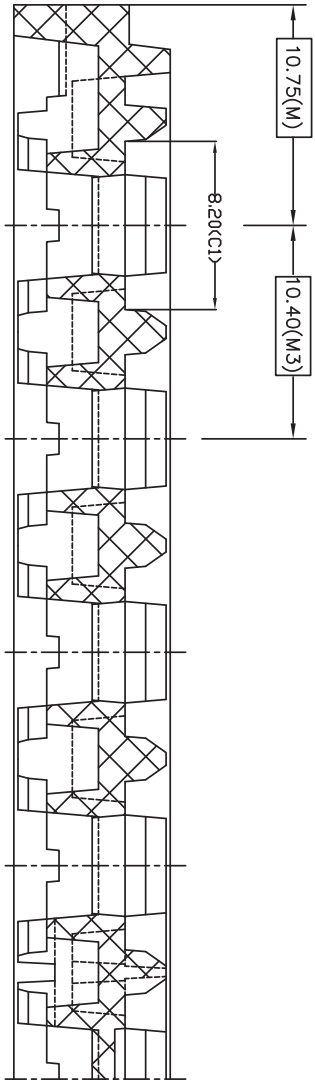

SECTION B-B

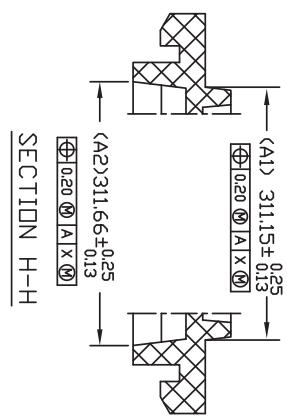

SECTION H-H

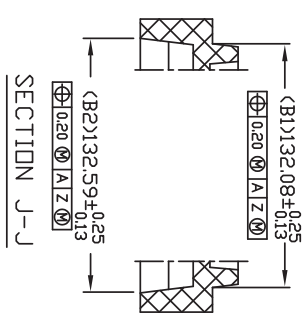

SECTION J-J

UNLESS OTHERWISE SPECIFIED:  
ALL DIMENSIONS:  
GENERAL TOLERANCE AS  
XX = ±0.25 ANGLES=±0.5°  
XXX = ±0.13

Copyright © ePAK International, Inc. All Rights Reserved.

ECN NO.	DESCRIPTION	DO NOT SCALE	DATE	PAGE 2 OF 3
	New Design		01 DEC 03	DRAWER: Jack Liu
			01 DEC 03	ENG. REVIEWED:
			01 DEC 03	QA REVIEWED:
			01 DEC 03	M/S REVIEWED:
			01 DEC 03	PRD. REVIEWED:
			01 DEC 03	APPROVED:
CUSTOMER: ePAK		RESOURCES		
DESCRIPTION: eN BG0808 1.7 1229 X R.1				
DWG NO.	MTF0463	REV.	0	

**BT-4000 tape dimensions**

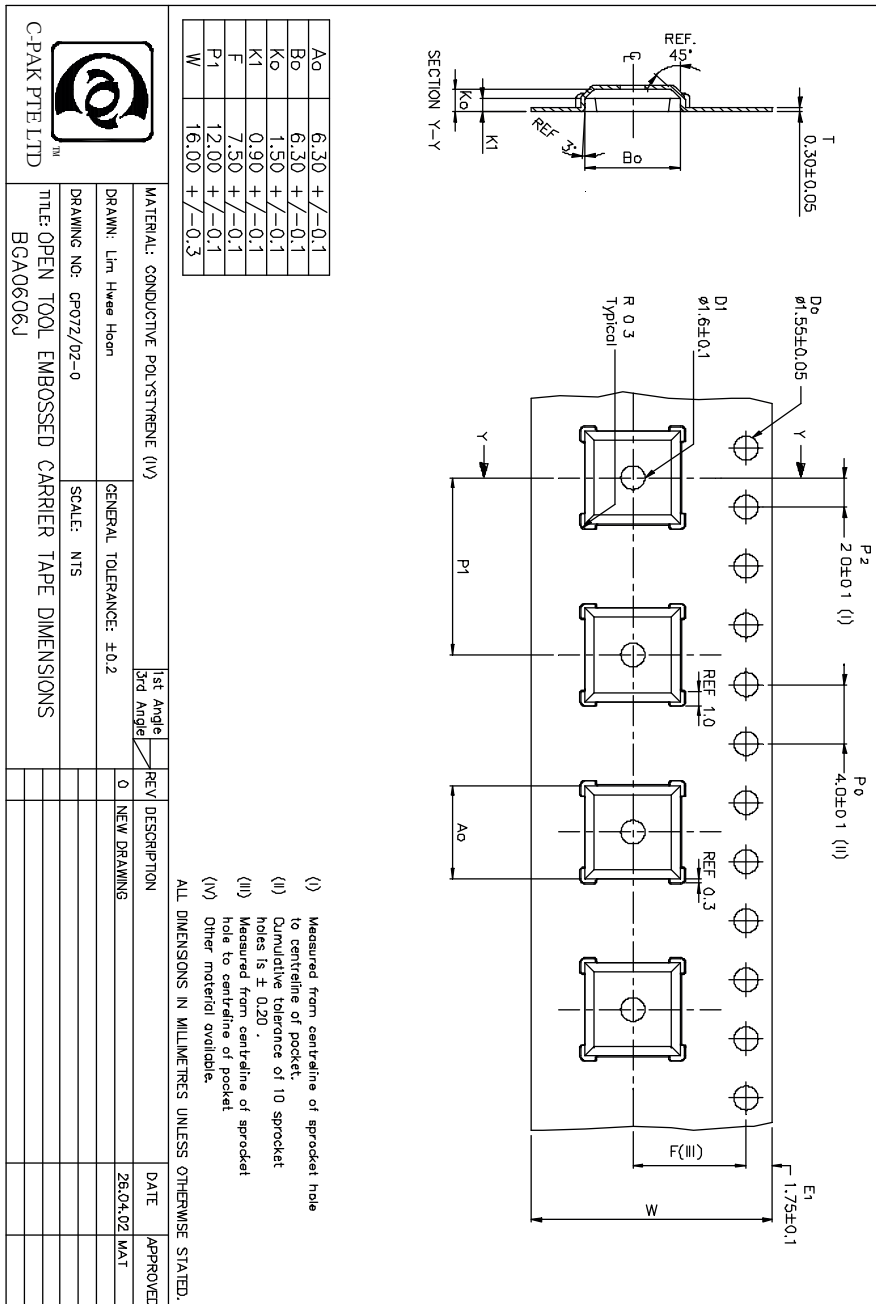

MATERIAL: CONDUCTIVE POLYSTYRENE (IV)		1st Angle	REV	DESCRIPTION	DATE	APPROVED
DRAWN: Lim Hwee Hoon	GENERAL TOLERANCE: $\pm 0.2$	3rd Angle	0	NEW DRAWING	26.04.02	MAT
DRAWING NO: CP072/02-0	SCALE: NTS					
TITLE: OPEN TOOL EMBOSSED CARRIER TAPE DIMENSIONS						
BGA0606J						
THIS DRAWING CONTAINS INFORMATION THAT IS PROPRIETARY TO C-PAK PTE.LTD.						

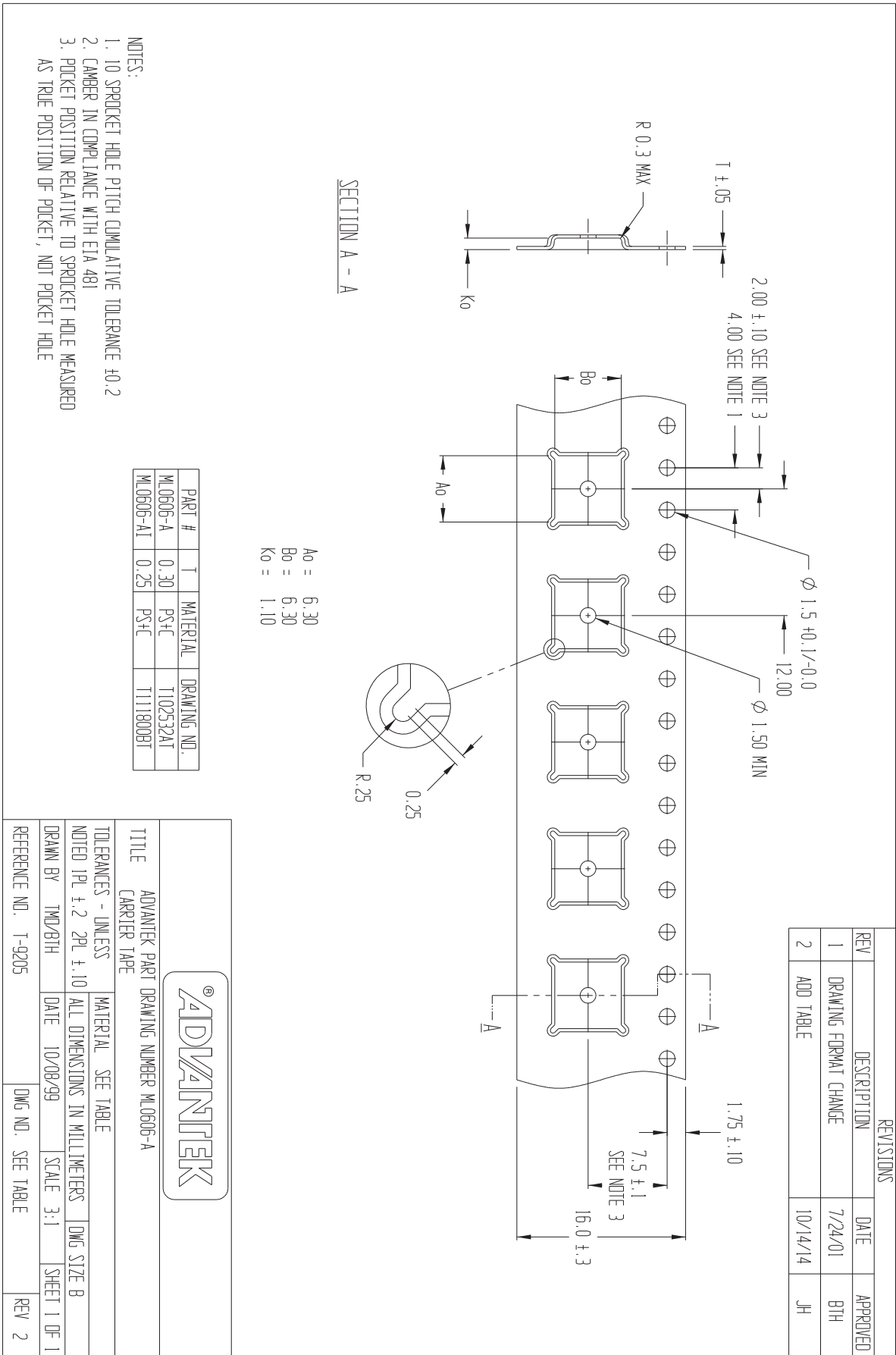

**Color coding of trays for SM-4200(M)** Observe the following color coding of trays for SM-4200:

SM-4200 SM-4200 (without MIFARE functionality) are not marked with a rider:



Illustration 7: Tray marking for SM-4200

SM-4200M SM-4200M (with MIFARE functionality) are marked with a red rider:



Illustration 8: Tray marking for SM-4200M

**Color coding of trays for SM-4500(M)** Observe the following color coding of trays for SM-4500:

SM-4500 SM-4500 (without MIFARE functionality) are marked with a purple rider:

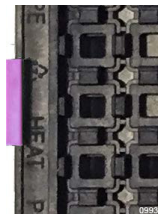

Illustration 9: Tray marking for SM-4500

SM-4500M SM-4500M (with MIFARE functionality) are marked with a purple and a red rider:

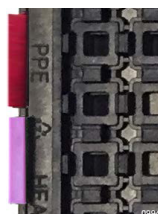

Illustration 10: Tray marking for SM-4500M